

THE NEW VALUE FRONTIER

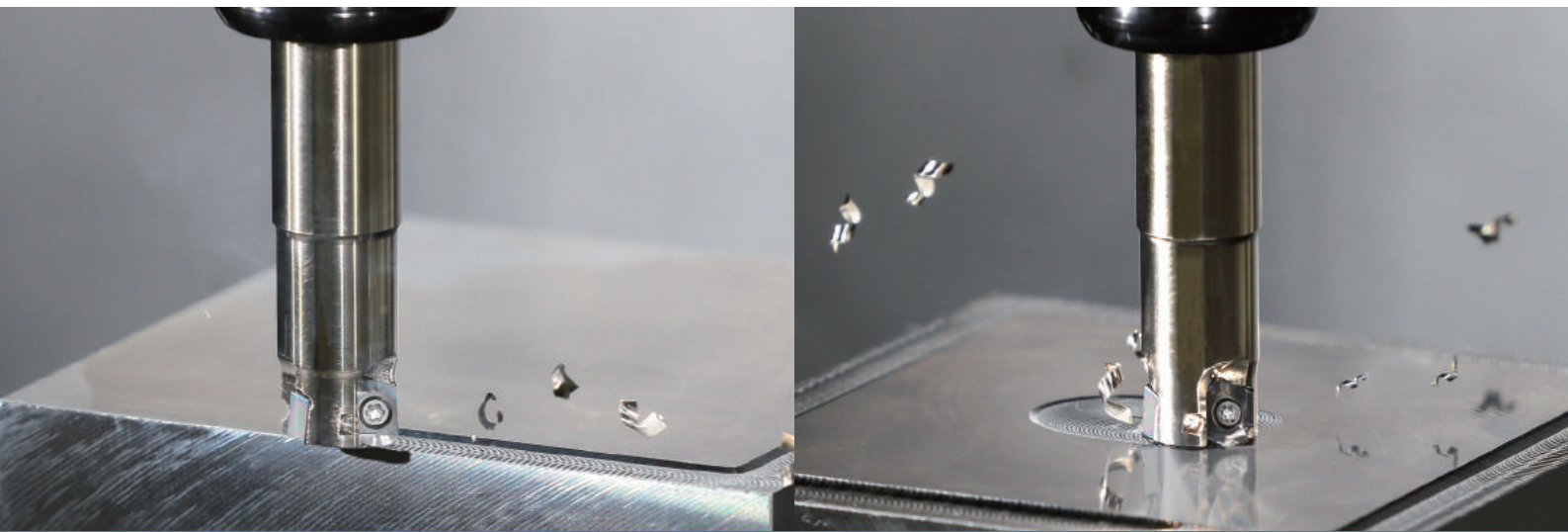

Micro diameter | **MFH** Micro
high feed mills

MFH Micro



Low resistance and durable against chatter for highly efficient machining

Shortens rough machining times

Replaces solid end mills to reduce machining costs

Supports small machining centers such as BT30



Micro diameter high feed mills

MFH Micro

- Low resistance and durable against chatter for highly efficient machining
- Maximum ap 0.5 mm
- Stable high feed machining on a wide range of applications

Molded convex cutting edge



High precision G class insert

1 Stable machining with chattering resistance

Molded convex cutting edge controls initial impact when entering the workpiece.

Cutting force comparison (In-house evaluation)

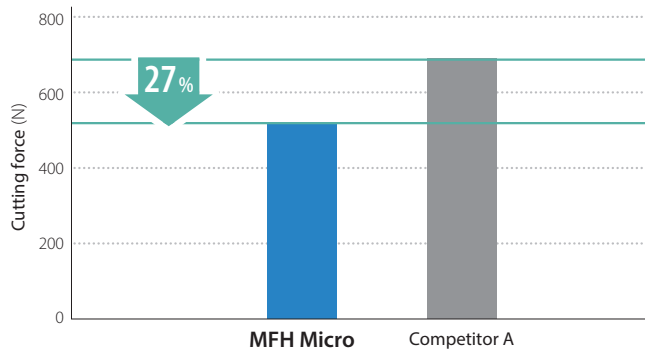

Cutting conditions: Vc = 120 m/min, fz = 0.6 mm/t, ap = 0.4 mm
Cutter dia. ø10 mm, slotting, dry; workpiece: C50

Increase in cutting force when entering workpiece (In-house evaluation)

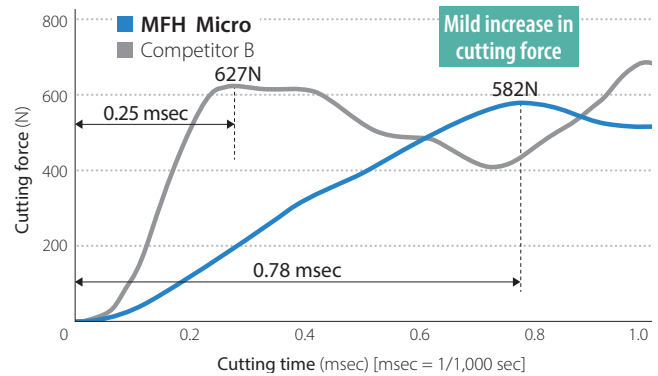

Cutting conditions: Vc = 120 m/min, fz = 0.6 mm/t, ap x ae = 0.4 x 5 mm
Cutter dia. ø10 mm, dry; workpiece: C50

2 Wide range of machining applications

- Wide range of machining applications with maximum ap 0.5 mm
- Stable machining even with small machining centers

Cutting performance (Cutter dia. ø10 mm)

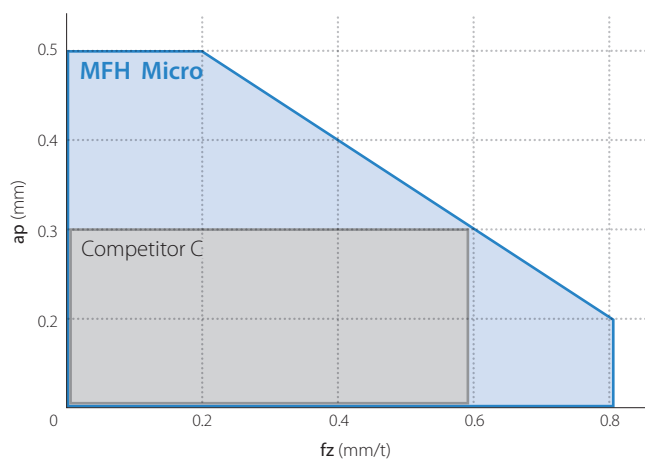

(In-house evaluation)

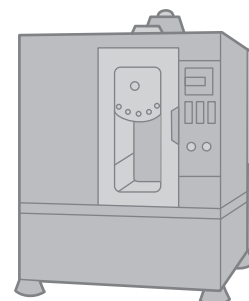

Supports BT30/BT40

3 Good chip evacuation

Fine surface by controlling chip biting.

MFH Micro

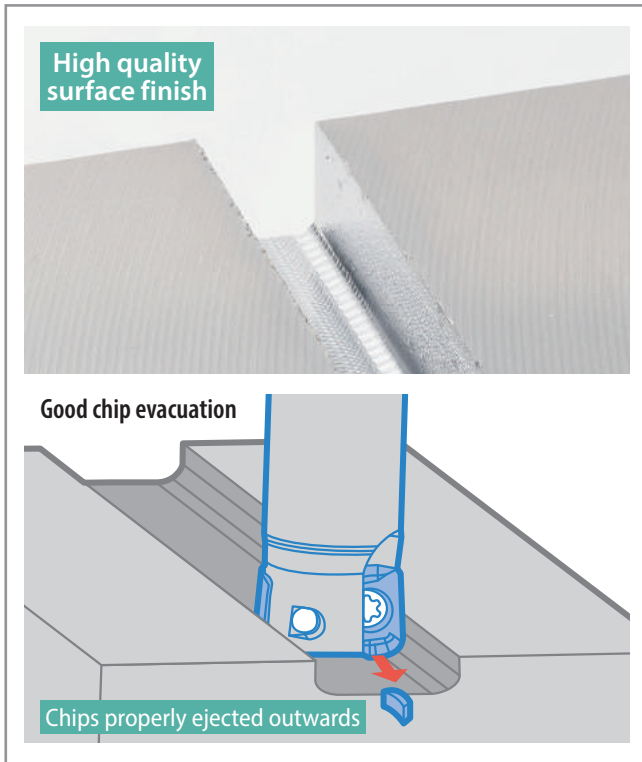

Competitor F

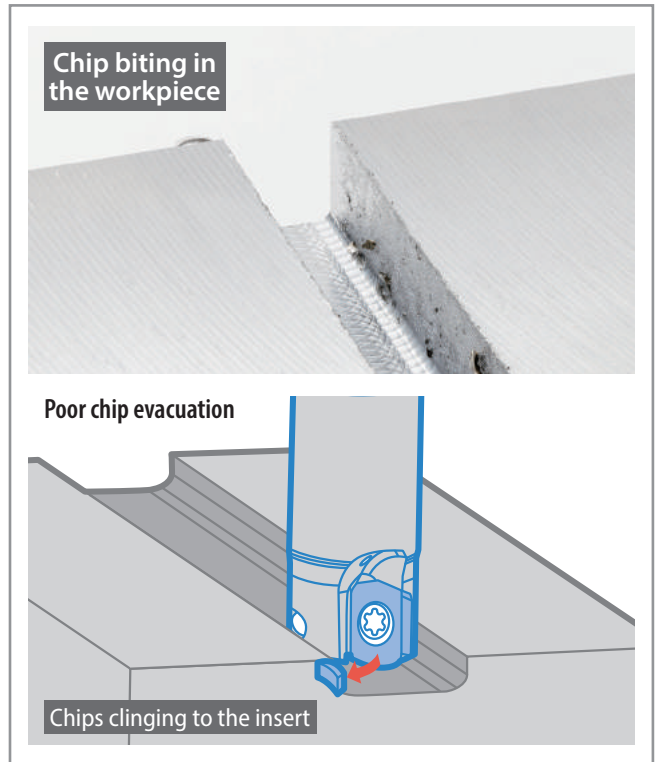

Cutting conditions: cutter dia. $D_c = \varnothing 10$ mm, $V_c = 120$ m/min, $f_z = 0.6$ mm/t, $a_p = 0.4$ mm (25 passes) total 10 mm, dry; workpiece: 1.0040

(In-house evaluation)

4 Replaces solid end mills to reduce machining costs

Suppresses chattering and increases milling efficiency.

MFH Micro compared to solid end mills

MFH Micro; $Q = 15.3$ cc/min

$V_c = 150$ m/min, $f_z = 0.4$ mm/t
 $a_p \times a_e = 0.4 \times 10$ mm, dry
 MFH10-S10-01-2T (2 Inserts)
 LPGT010210ER-GM (PR1525)

Solid end mill; $Q = 12.2$ cc/min

$V_c = 80$ m/min, $f_z = 0.04$ mm/t
 $a_p \times a_e = 3 \times 10$ mm, dry
 $\varnothing 10$ (4 Flute)

Mechanical parts - slotting

Workpiece: C50

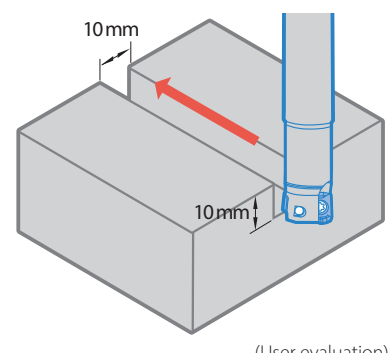
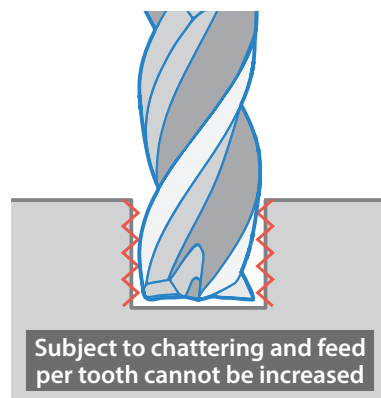
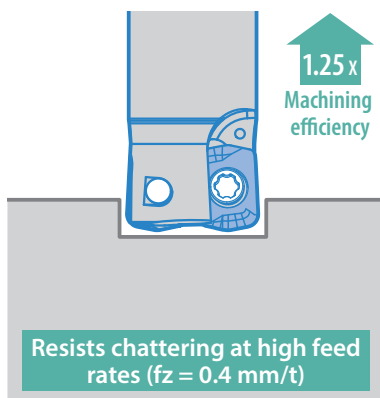

MEGACOAT NANO PR1535

For stable machining of difficult-to-cut materials such as heat-resistant alloy, titanium, and precipitation hardened stainless steel

1 Toughening by a new cobalt mixing ratio

An increase in cobalt content yields a substrate with greater toughness. Fracture toughness values are improved by 23 % over previous grades.

High toughness carbide base material

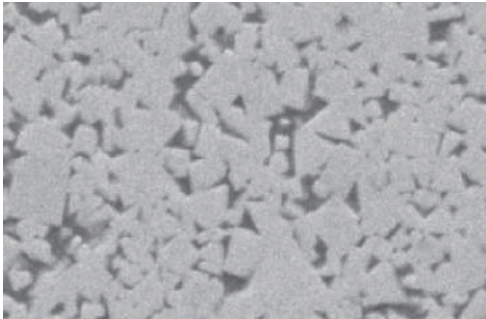

↑ 23% Fracture toughness

2 Stability improvement

The coarse grain structure and uniform particle size correspond to improved heat resistance, with conductivity values decreased by 11 %. The uniform structure also reduces crack propagation.

Crack comparison by diamond indenter (In-house evaluation)

↑ Shock resistance

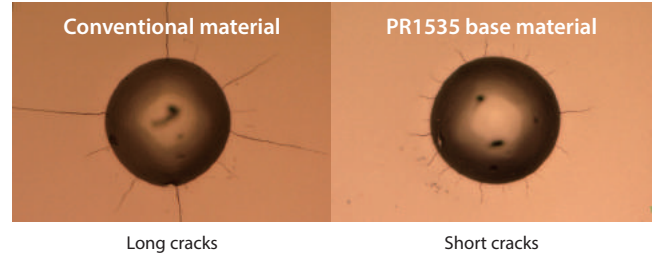

Coating properties (Wear resistance)

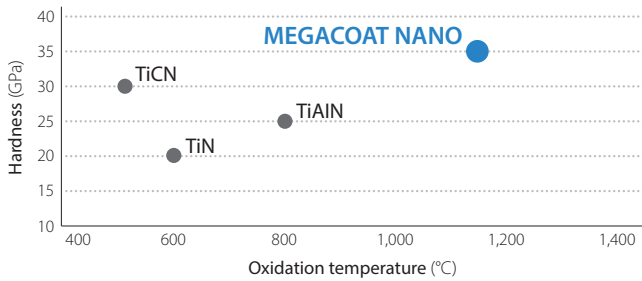

Low Oxidation resistance High

Achieves long tool life with the combination of a tough substrate and a special nano coating layer

Coating properties (Deposition resistance)

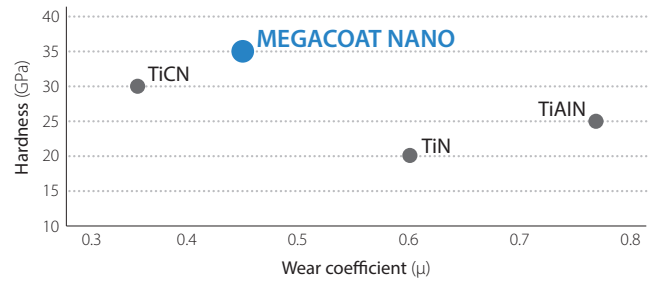

High Deposition resistance Low

Stable machining with excellent wear resistance

Fracture resistance comparison (In-house evaluation)

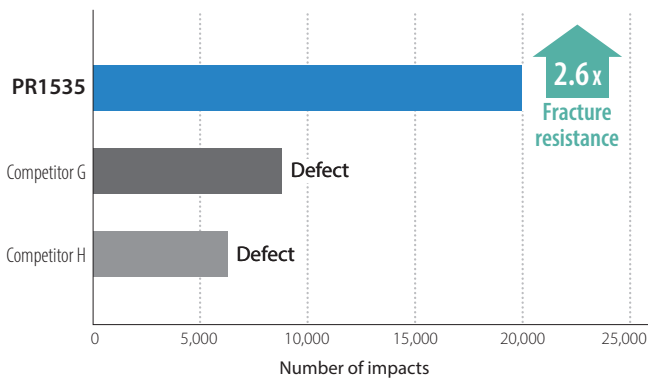

↑ 2.6x Fracture resistance

Cutting conditions: Vc = 120 m/min, fz = 1.5 mm/t, ap x ae = 0.4 mm x 2.5 mm
Cutting dia. ø10, dry; workpiece: X40CrMoV5-1 (40 to 45 HRC)

Wear resistance comparison (In-house evaluation)

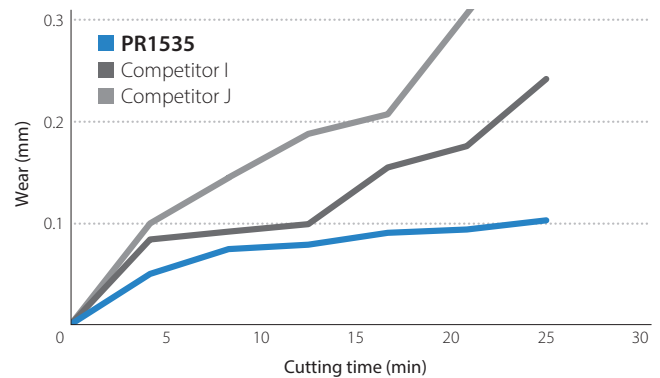

Cutting conditions: Vc = 180 m/min, fz = 0.5 mm/t, ap x ae = 0.3 x 8 mm
Cutting dia. ø10, dry; workpiece: X5CrNi18-10

MFH Micro

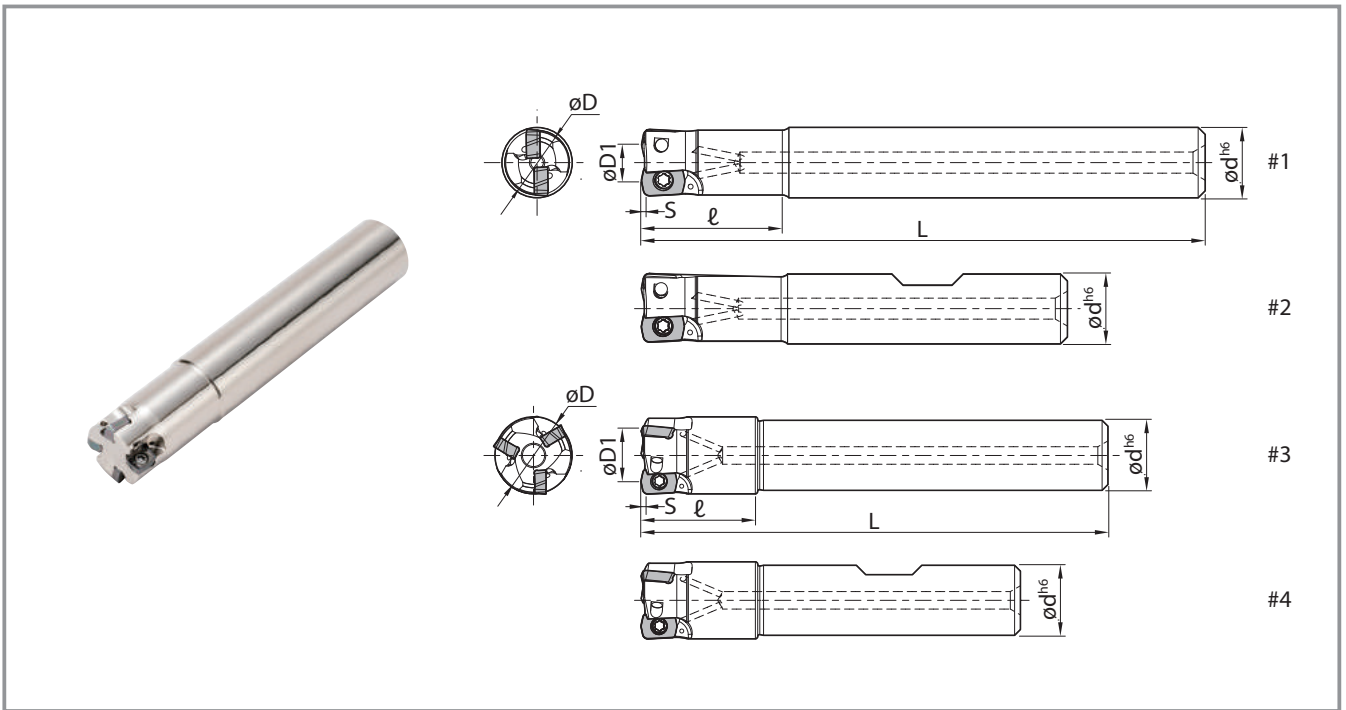



Toolholder dimensions

Shank	Description	Availability	No. of inserts	Dimensions (mm)						Maximum ramping angle	A.R.	Coolant hole	Shape	Weight (kg)	Max. revolution (min ⁻¹)	Clamp screw
				øD	øD1	ød	L	ℓ	S							
Standard	MFH08-S10-01-1T	●	1	8	4.2	10	75	16	0.5	4°	5°	Yes	#1	0.04	20,000	SB-1840TRP
	MFH10-S10-01-2T	●	2	10	6.2	10	80	20		3°				0.04	16,200	
	MFH12-S12-01-3T	●	3	12	8.2	12	80	20		2°				0.06	14,000	
	MFH16-S16-01-4T	●	4	16	12.2	16	90	25		1.2°				0.12	11,400	
Long shank	MFH14-S12-01-3T	●	3	14	10.2	12	80	20	0.5	1.5°	5°	Yes	#3	0.07	12,500	
Standard (Weldon)	MFH08-W10-01-1T	●	1	8	4.2	10	58	16	0.5	4°	5°	Yes	#2	0.03	20,000	
	MFH10-W10-01-2T	●	2	10	6.2	10	60	20		3°				0.03	16,200	
	MFH12-W12-01-3T	●	3	12	8.2	12	65	20		2°				0.05	14,000	
	MFH16-W16-01-4T	●	4	16	12.2	16	73	25		1.2°				0.1	11,400	
Oversize (Weldon)	MFH14-W12-01-3T	●	3	14	10.2	12	65	20	0.5	1.5°	5°	Yes	#4	0.05	12,500	

● Available

Spare parts

Description	Spare parts			Applicable inserts
	Clamp screw	Wrench	Anti-seize compound	
				
MFH...-01-...	SB-1840TRP	FTP-6	MP-1	LPGT010210ER-GM

Applicable inserts

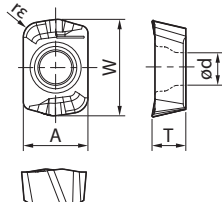
Shape	Description	Dimensions (mm)					MEGACOAT NANO		CVD coating
		A	T	ø d	W	re	PR1525	PR1535	CA6535
 General purpose 	LPGT 010210ER-GM	4.19	2.19	2.1	6.26	1.0	●	●	●

● Available

Cutting performance

Cutter dia: ø8 to ø12

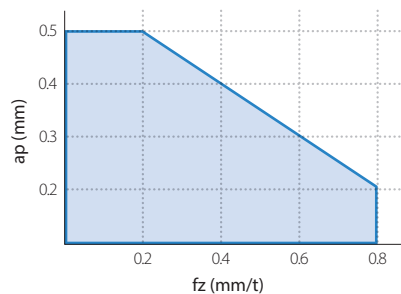

Cutter dia: ø14 to ø16

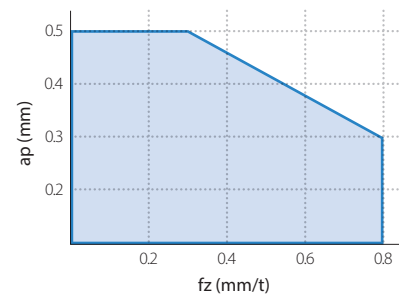

Recommended cutting conditions ★ 1st recommendation ☆ 2nd recommendation

Chipbreaker	Workpiece	Holder description and recommended feed rate (fz: mm/t) Recommended ap = 0.3 mm reference value					Recommended insert grade and cutting speed (Vc: m/min)		
		MFH08-... -1T	MFH10-... -2T	MFH12-... -3T	MFH14-... -3T	MFH16-... -4T	MEGACOAT NANO		CVD coating
								PR1525	PR1535
GM	Carbon steel	0.2 – 0.4 – 0.6			0.2 – 0.5 – 0.8		★ 120 – 180 – 250	☆ 120 – 180 – 250	—
	Alloy steel	0.2 – 0.4 – 0.6			0.2 – 0.5 – 0.8		★ 100 – 160 – 220	☆ 100 – 160 – 220	—
	Mold steel (~40 HRC)	0.2 – 0.3 – 0.5			0.2 – 0.4 – 0.6		★ 80 – 140 – 180	☆ 80 – 140 – 180	—
	Mold steel (40 ~ 50 HRC)	0.2 – 0.25 – 0.3			0.2 – 0.25 – 0.4		★ 60 – 100 – 130	☆ 60 – 100 – 130	—
	Austenitic stainless steel						☆ 100 – 160 – 200	★ 100 – 160 – 200	—
	Martensitic stainless steel	0.2 – 0.3 – 0.5			0.2 – 0.4 – 0.6		—	☆ 150 – 200 – 250	★ 180 – 240 – 300
	Precipitation hardened stainless steel						—	★ 90 – 120 – 150	—
	Gray cast iron	0.2 – 0.4 – 0.6			0.2 – 0.5 – 0.8		★ 120 – 180 – 250	—	—
	Nodular cast iron	0.2 – 0.3 – 0.5			0.2 – 0.4 – 0.6		★ 100 – 150 – 200	—	—
	Ni-based heat-resistant alloy (Inconel®718, etc.)	0.2 – 0.25 – 0.3			0.2 – 0.25 – 0.4		—	☆ 20 – 30 – 50	★ 20 – 30 – 50
	Titanium alloy						—	★ 40 – 60 – 80	—

- Machining with coolant is recommended for Ni-base heat-resistant alloy and titanium alloy
- The numbers in bold are the recommended starting conditions
- Adjust the cutting speed and the feed rate within the above conditions according to the actual machining situation
- Internal coolant is recommended for slotting applications

Approximate programming radius adjustment

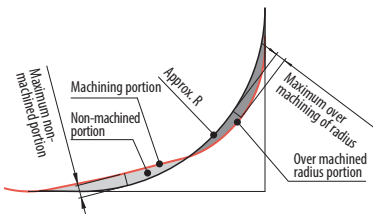
Drawing	Approx. R (mm)	Maximum over machining of radius (mm)	Maximum non-machined portion (mm)
	R1.0	0	0.21
	R1.2 (Recommended)	0	0.17
	R1.5	0.08	0.1
	R2.0	0.28	0.01

Cutting edge angle: 12°

Ramping reference data

Description	Cutter dia. ϕD (mm)	8	10	12	14	16
MFH...-01-...	Maximum ramping angle α_{max}	4.0°	3.0°	2.0°	1.5°	1.2°
	$\tan \alpha_{max}$	0.070	0.052	0.035	0.026	0.021

Decrease ramping angle if chips become excessively long.

Ramping

- Ramping angle should be under α_{max} (maximum ramping angle) in the above conditions
- Reduce recommended feed rate in cutting conditions above by 70 %

Formula for max. cutting length
(L) at max. ramping angle

$$L = \frac{ap}{\tan \alpha_{max}}$$

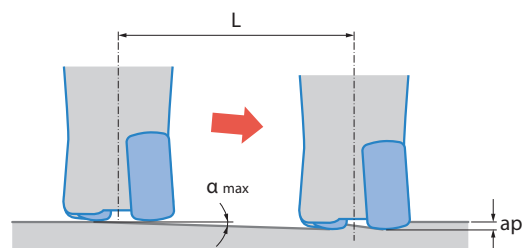

Helical milling

For helical milling, use between minimum and maximum cutting diameter.

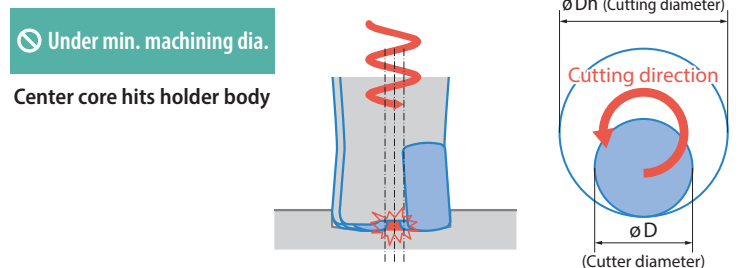
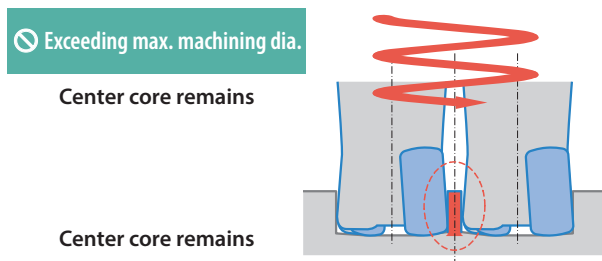

Holder	Min. cutting dia. $\phi Dh1$	Max. cutting dia. $\phi Dh2$
MFH...-01-...	$2 \times D - 3.5$	$2 \times D - 2$

Unit: mm

- Keep machine depth per rotation less than max. ap (0.5 mm)
- Use climb milling (See figure on right)
- Feed rates should be reduced to 50 % of recommended cutting condition
- Use caution to eliminate incidences caused by producing long chips

Peck milling

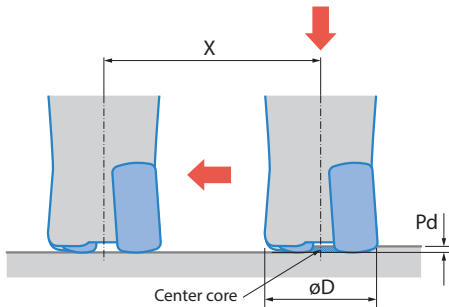

Holder	GM	
	Max. cutting depth (Pd)	Min. cutting length X for flat bottom surface
MFH...-01-...	0.5	$\phi D - 3.5$

Unit: mm

- Reduce feed rate 25 % or less of the recommended conditions until the center core part (unmachined part) is removed.
- When pecking, reduce feed rate per revolution to under $f = 0.2 \text{ mm/rev.}$

Vertical milling (Plunging)

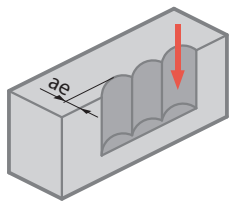

Vertical milling

Insert description	Maximum width of cut (ae)
LPGT01 type	1.7 mm

When plunging, reduce feed rate to $fz = 0.2 \text{ mm/t}$ or less.

MFH series

Small dia. cutter for high feed machining

MFH Mini

Cutter dia. $\phi 16$ to $\phi 32$

- Economical inserts with 4 cutting edges
- High efficiency with small dia. and fine pitch
- High feed machining



High feed machining

MFH

Cutter dia. $\phi 25$ to $\phi 160$

Large lineup for high feed machining, large ap and low cutting force.

